

2.9

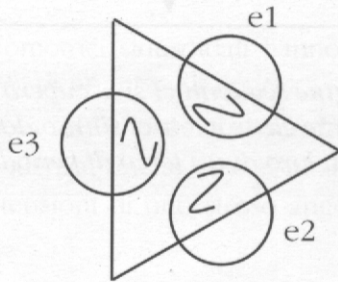

3.9

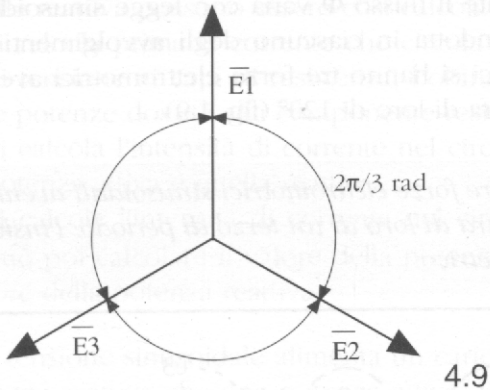

4.9

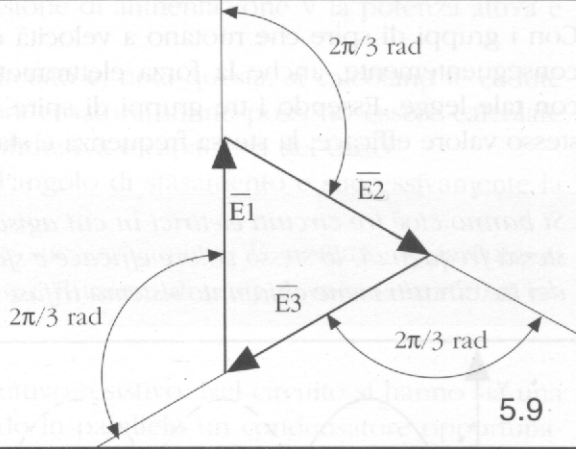

5.9

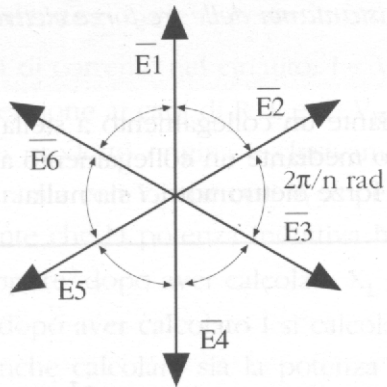

6.9

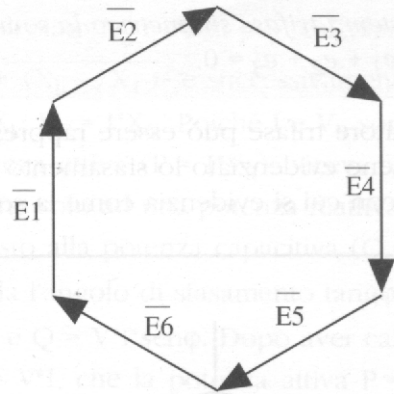

7.9

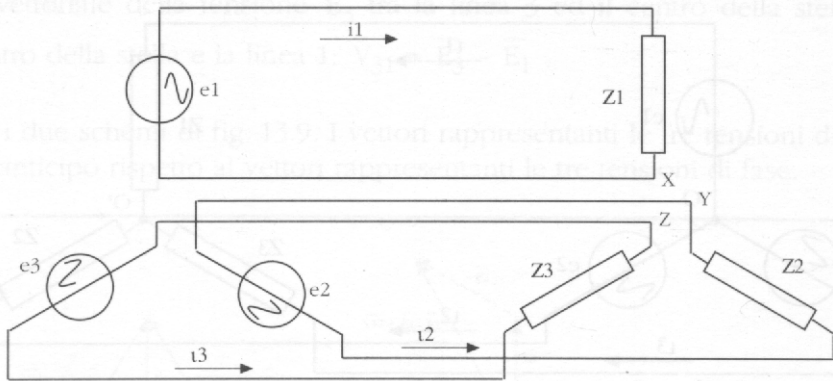

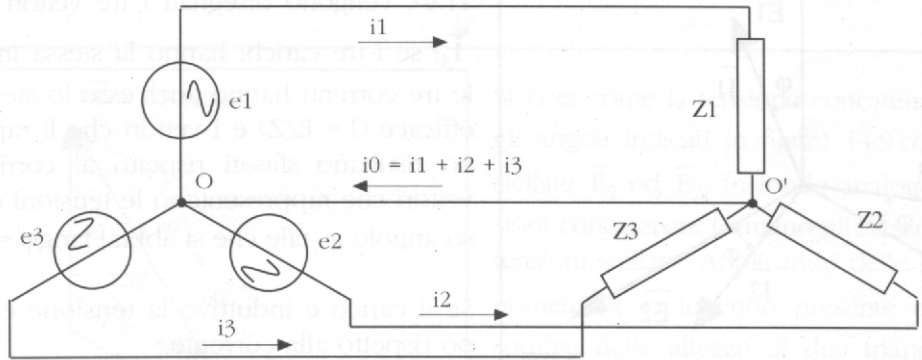

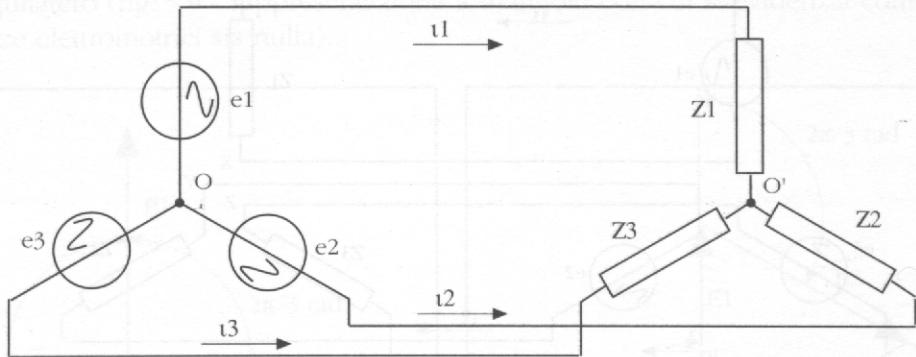

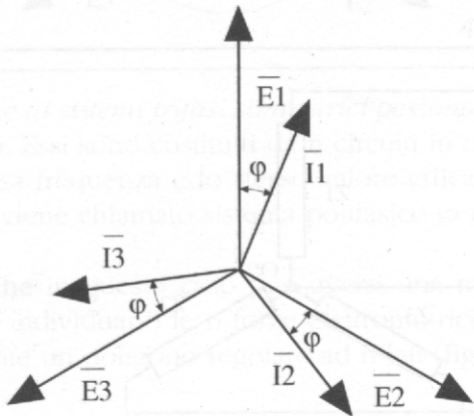

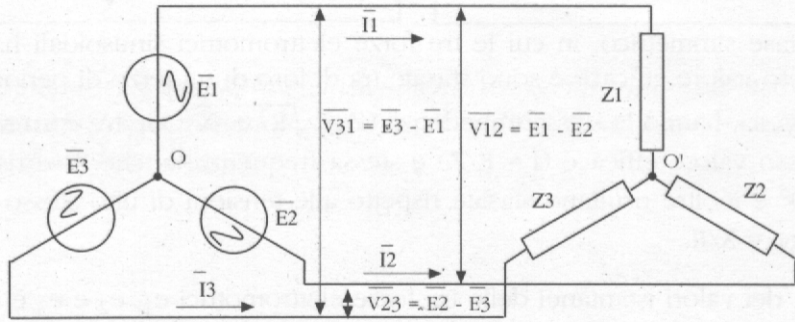

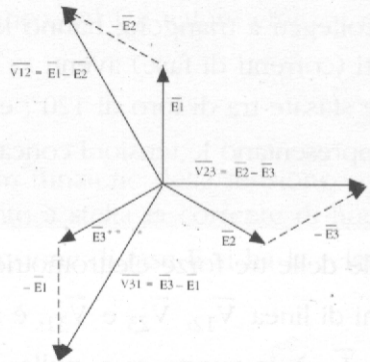
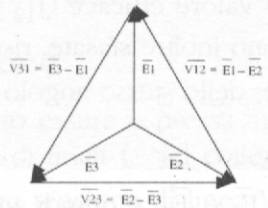

$$\vec{V}_{12} = \vec{E}_1 - \vec{E}_2$$

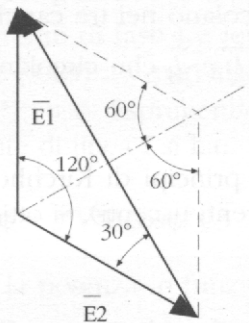

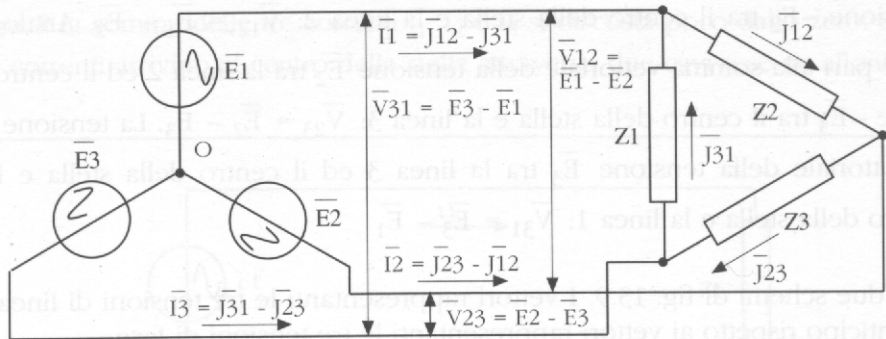

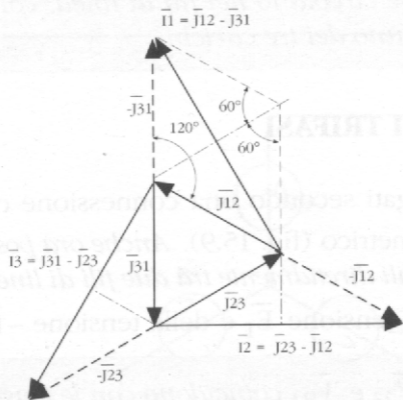

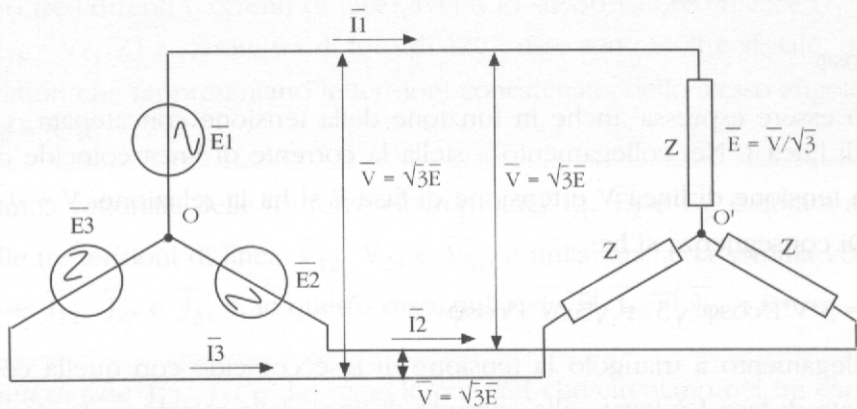

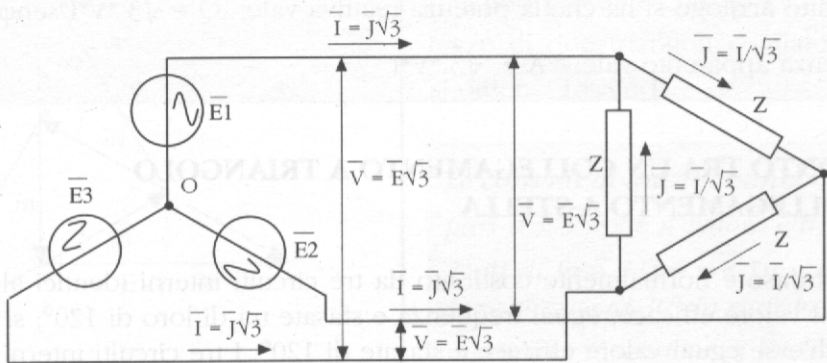

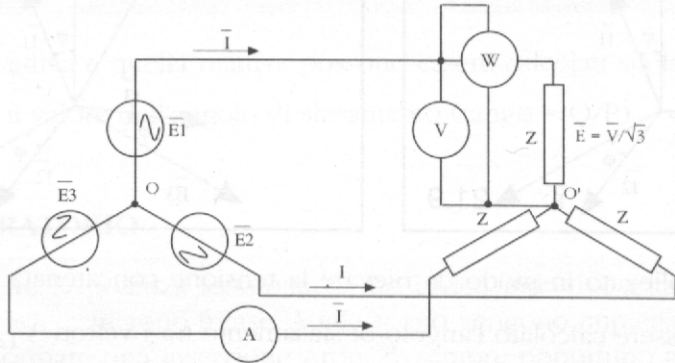

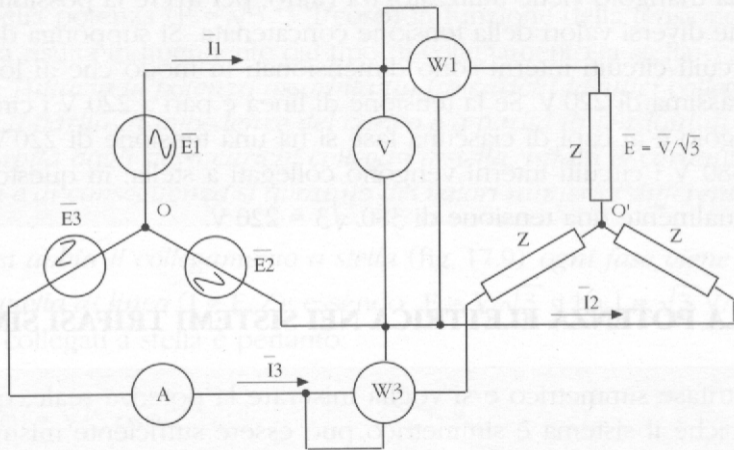

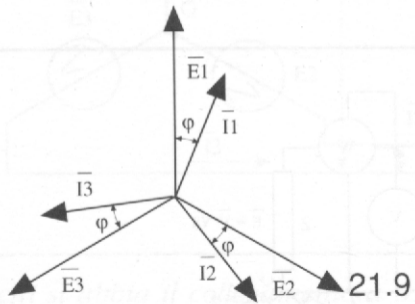

21.9

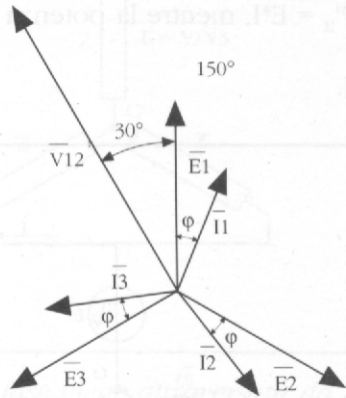

22.9

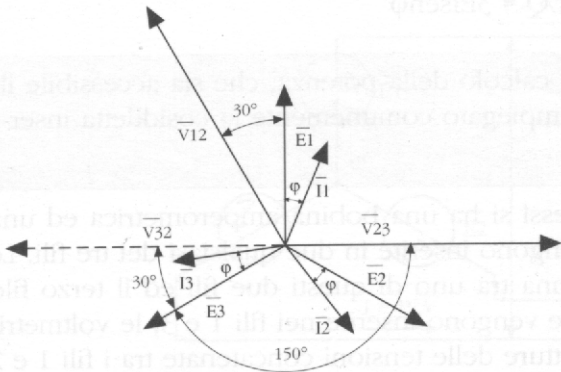

23.9