

Compressore

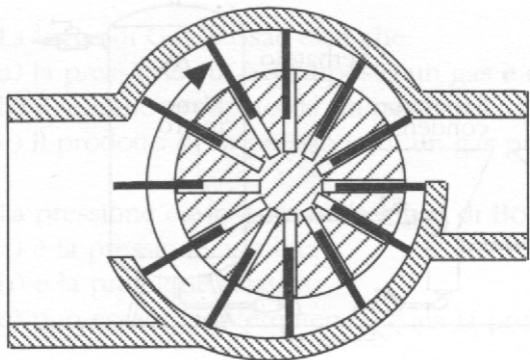

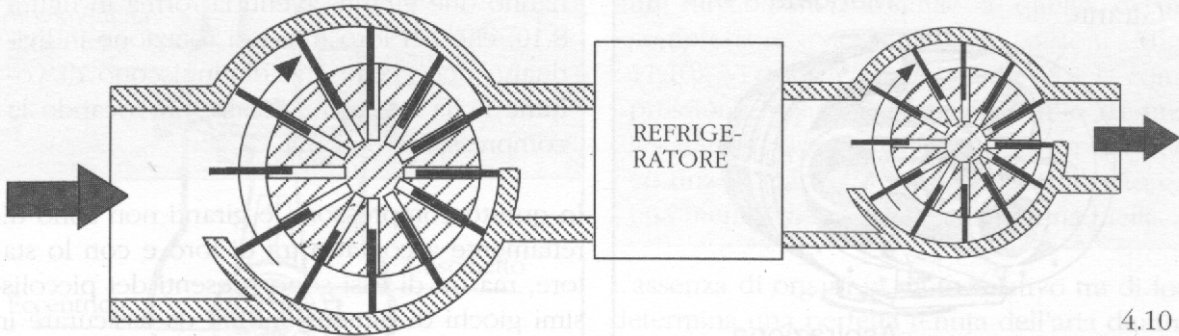

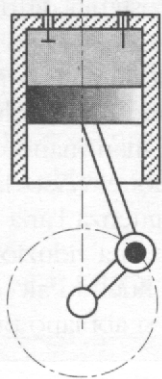

5.10

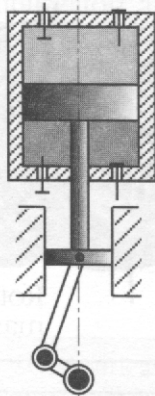

6.10

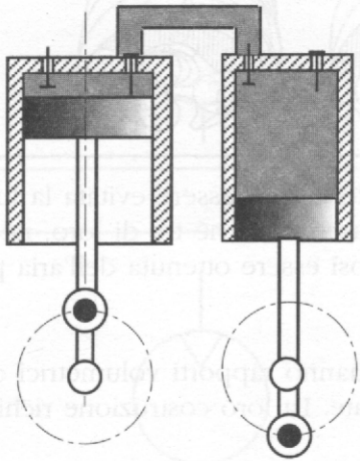

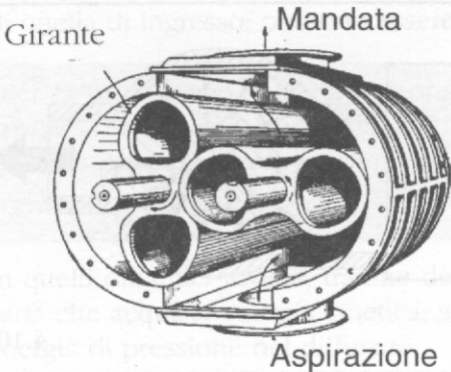

Tenuta
meccanica

Rotore
femmina

Cuscinetti

Albero

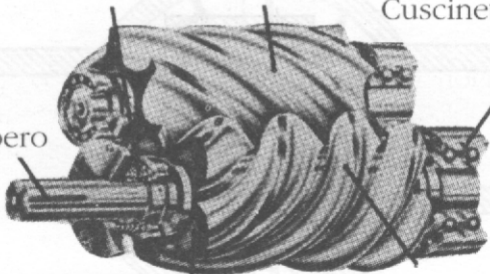

Profili dei
rotori

Rotore
maschio

9.10

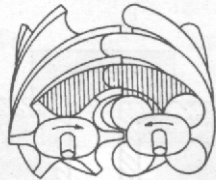
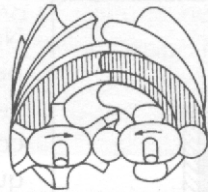
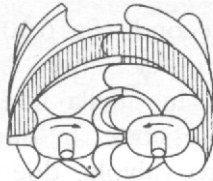
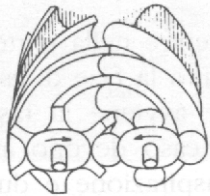

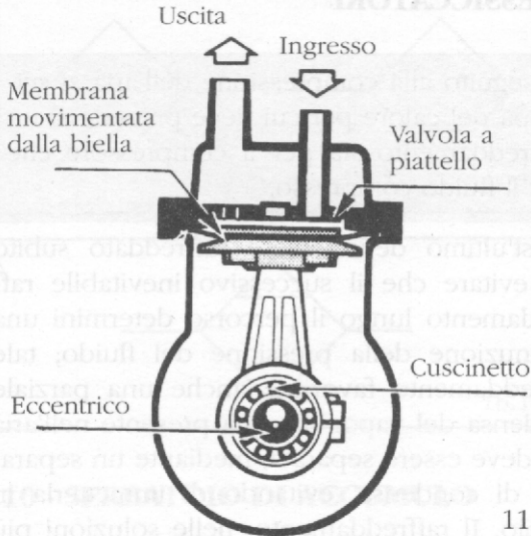

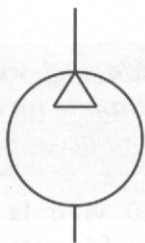

12.10

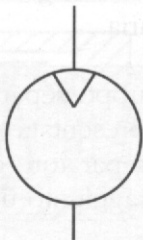

13.10

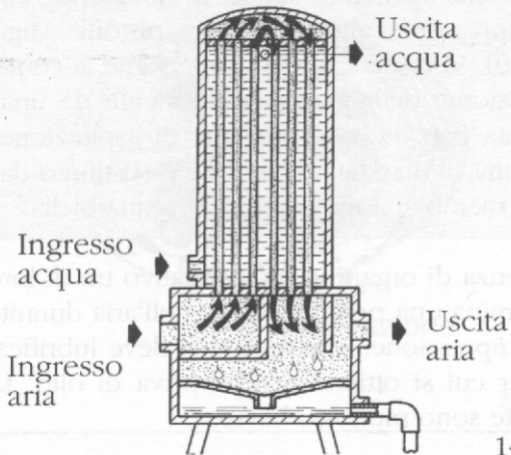

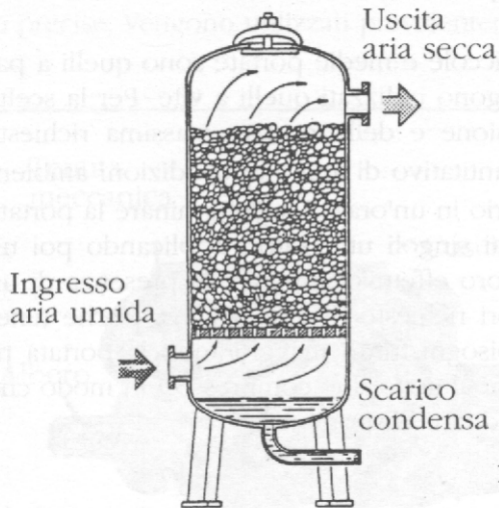

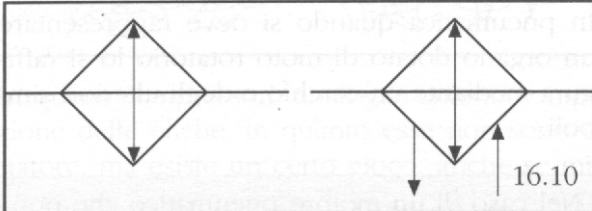

16.10

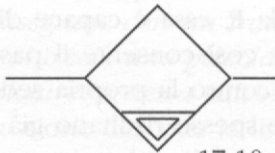
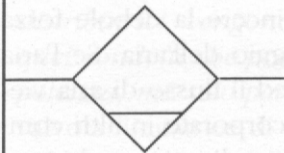

17.10

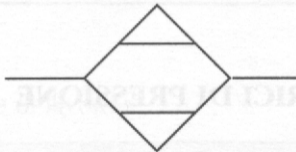

18.10

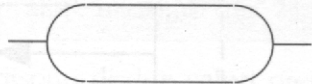
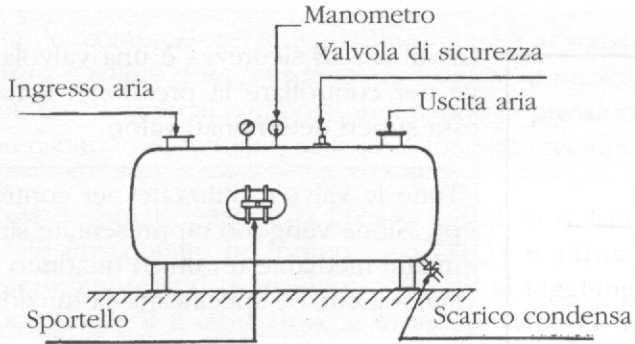

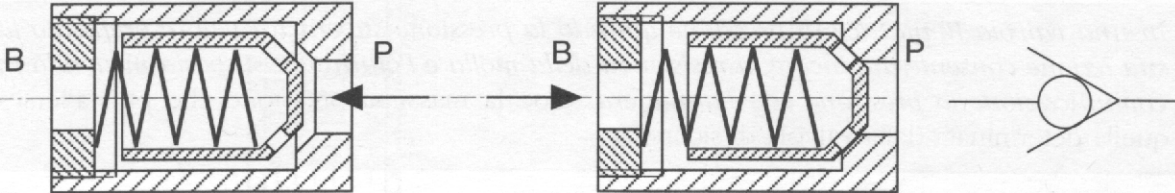

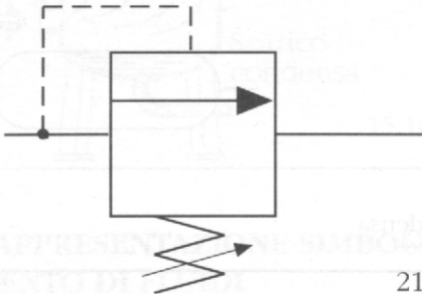

21.10

Tubazione di lavoro,
di ritorno,
di alimentazione



Tubazione di pilotaggio



Tubazione di fuga
(trafilamento)



Tubo collegato
a parti mobili



Giunzioni

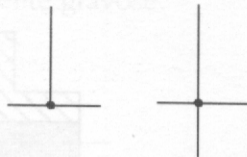

Incrocio senza
giunzione

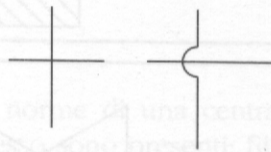

Diramazioni per
prese pressione e
misure



Con tubazione
allacciata

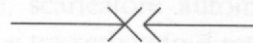

S1Q

S2Q

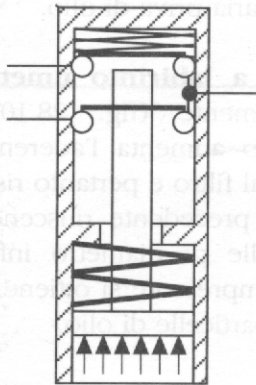

S1Q

S2Q

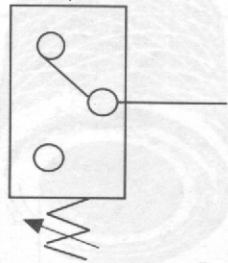

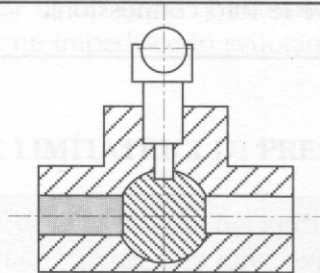
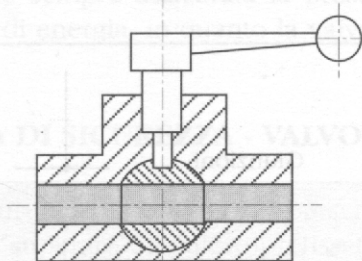

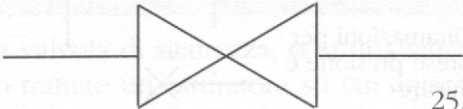

25.10

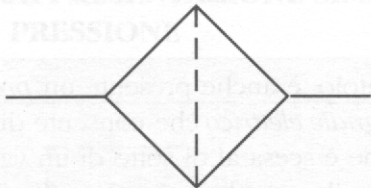

26.10

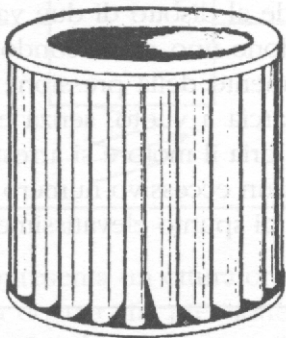

27.10

Gabbia
esterna

Rete
filtrante

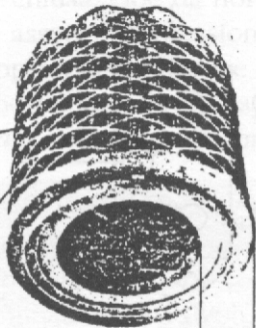

28.10

Spessore
filtrante

