

Emettitore

Base

Collettore

1.12

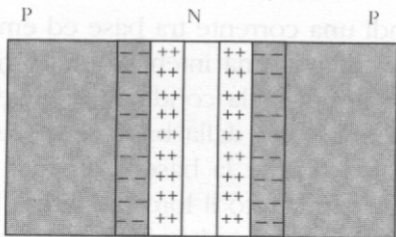

Emettitore

Base

Collettore

2.12

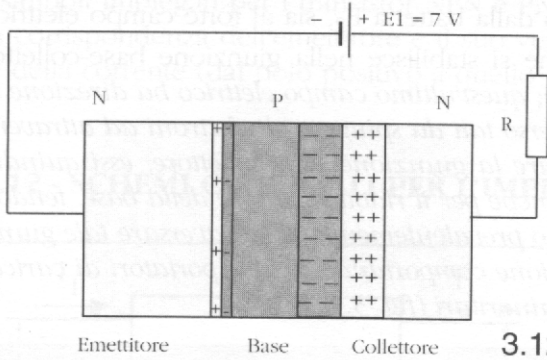

3.12

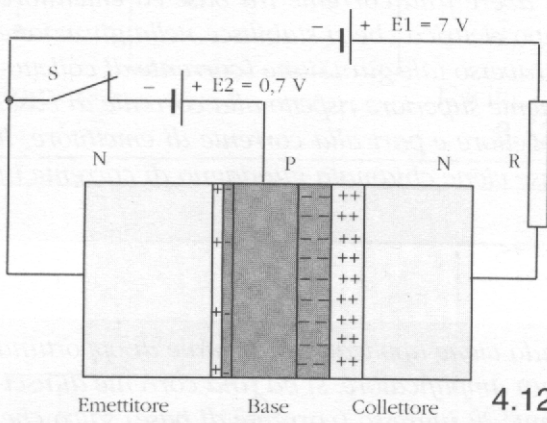

4.12

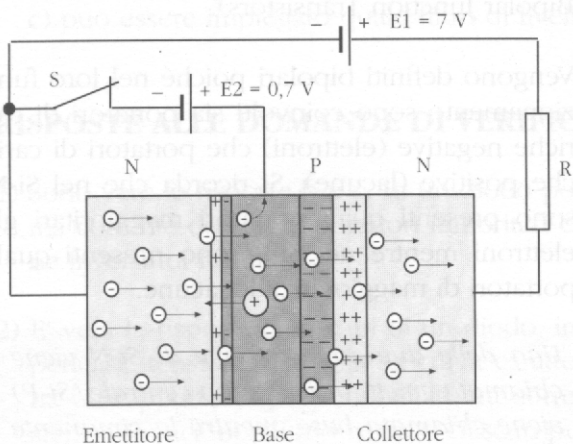

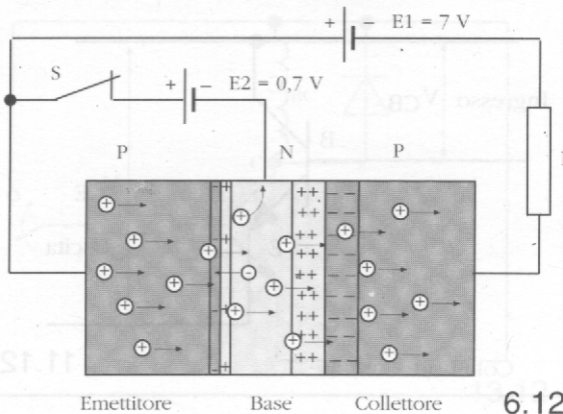

6.12

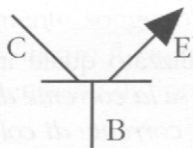

NPN

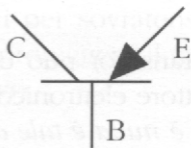

PNP

7.12

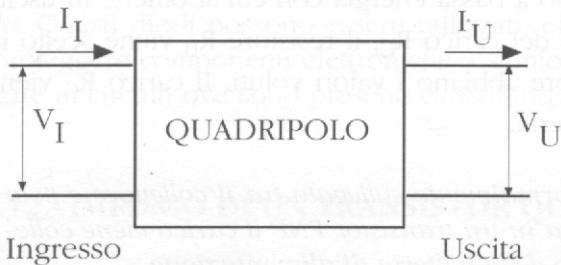

8.12

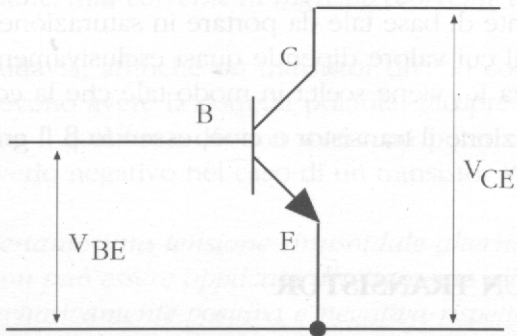

Emettitore comune

9.12

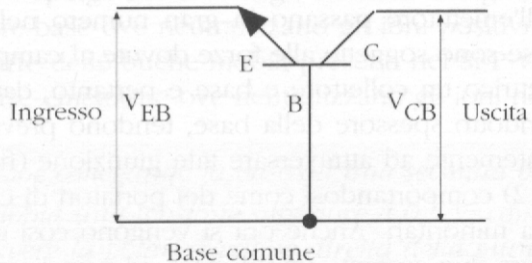

10.12

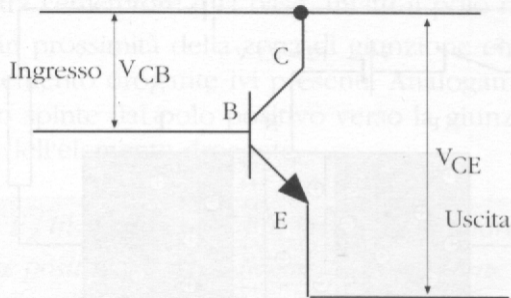

Collettore comune

11.12

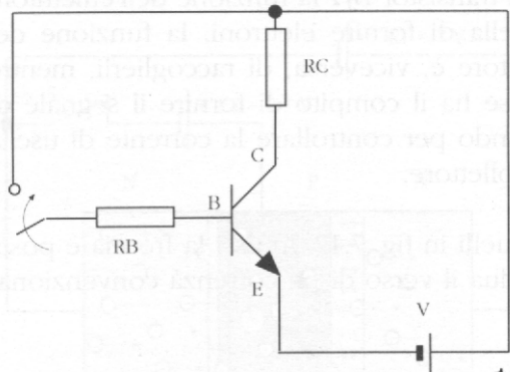

12.12

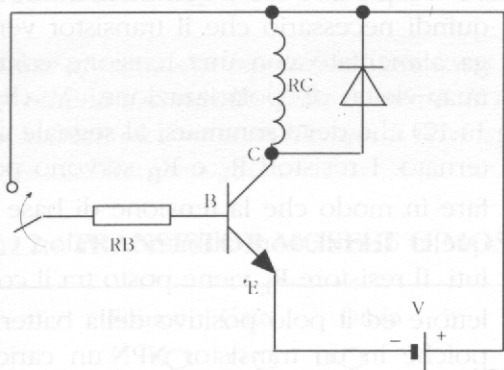

13.12



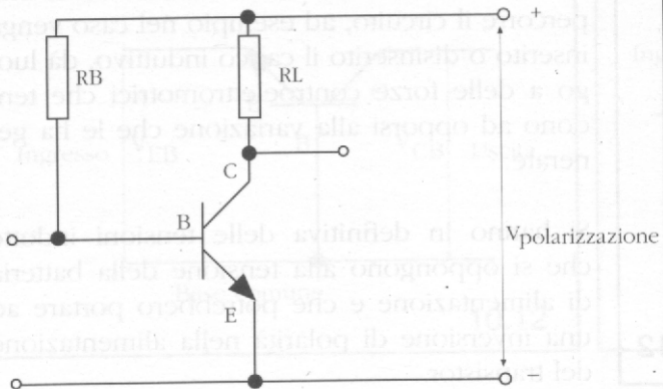

14.12

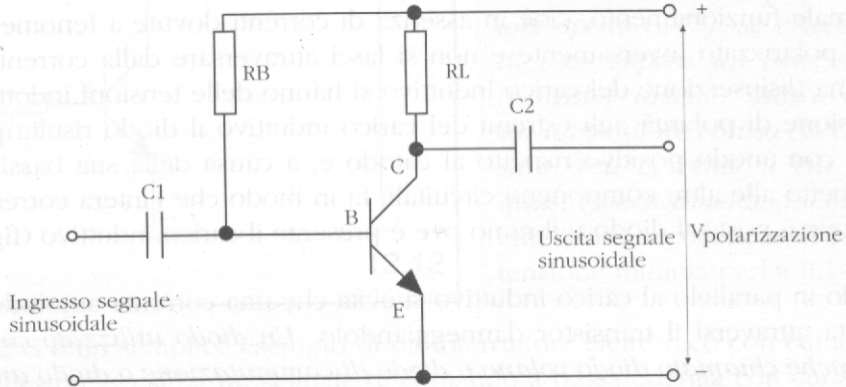

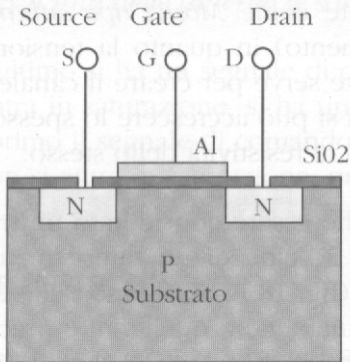

16.12

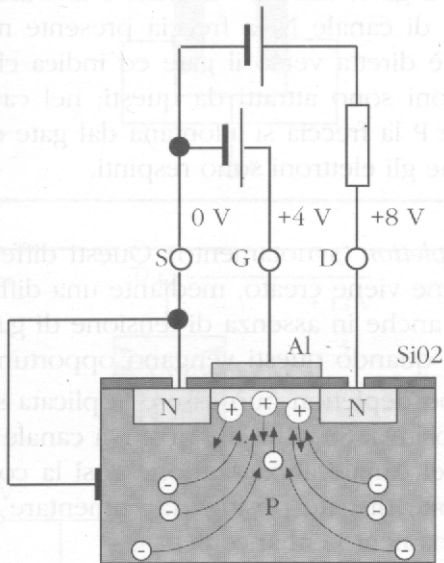

17.12

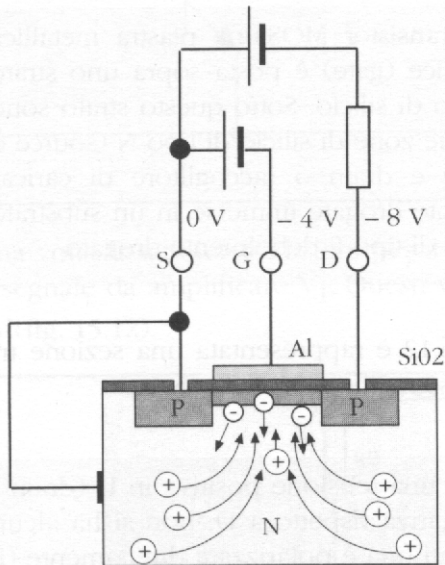

18.12

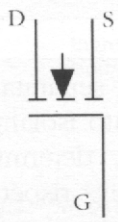

MOSFET canale N

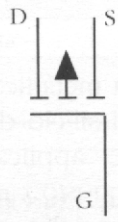

MOSFET canale P

19.12

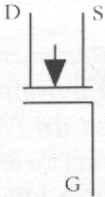

MOSFET canale N

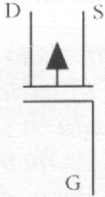

MOSFET canale P

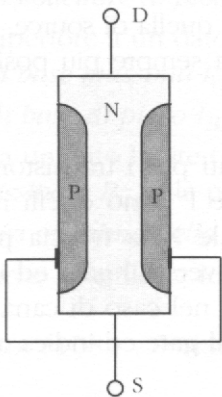

21.12

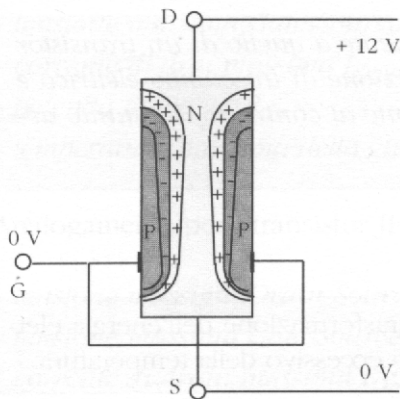

22.12

D  $+ 12 \text{ V}$

$- 2 \text{ V}$   
G

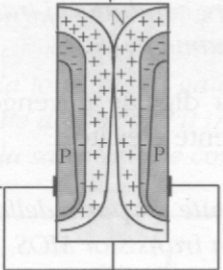

S  $0 \text{ V}$

23.12



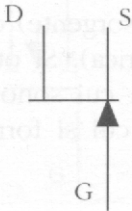

JFET canale N

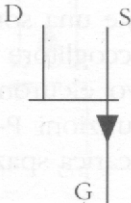

JFET canale P

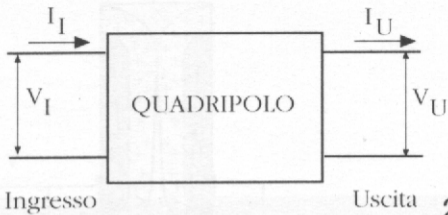

25.12

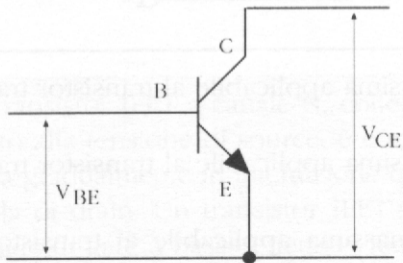

26.12

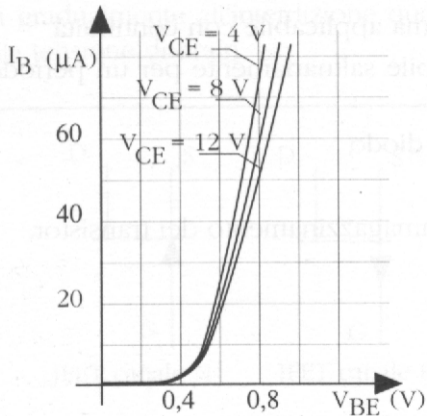

28.12

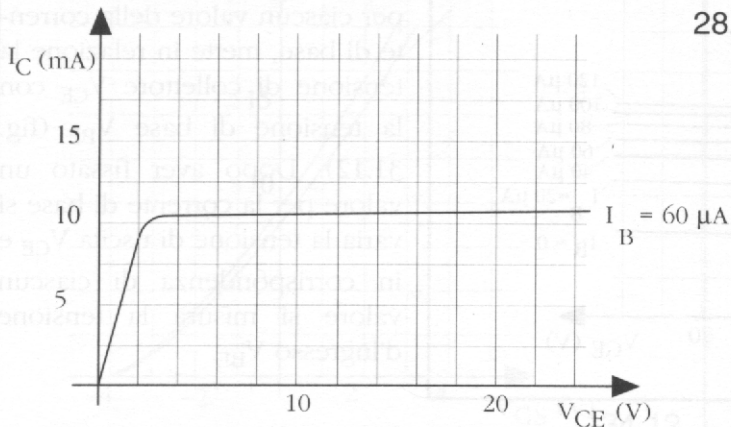

29.12

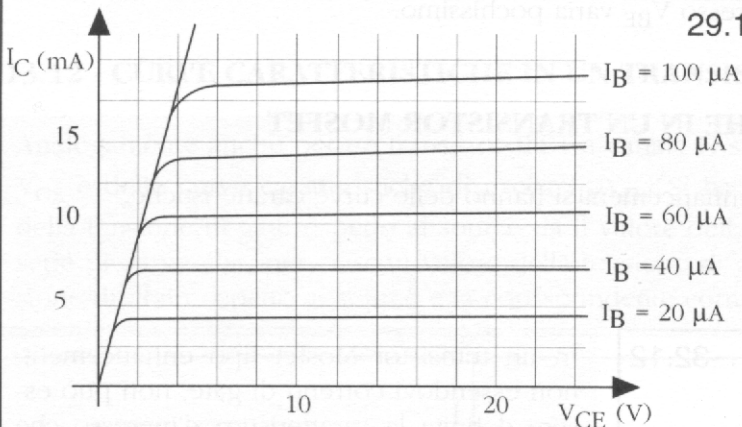

30.12

 $V_{CE} = 12\text{ V}$  $V_{CE} = 6\text{ V}$  $I_C$  (mA)

15

10

5

40

60

80

100

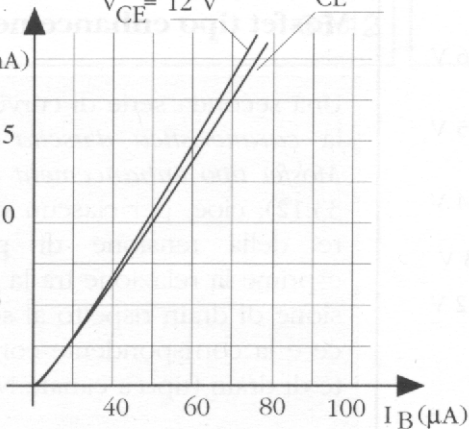
 $I_B$  ( $\mu\text{A}$ )

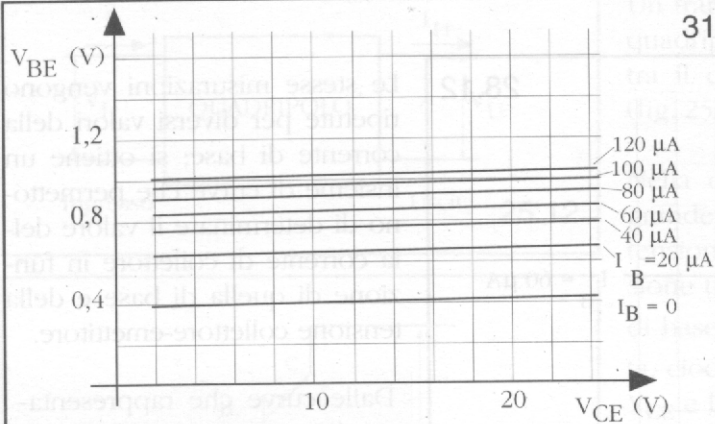

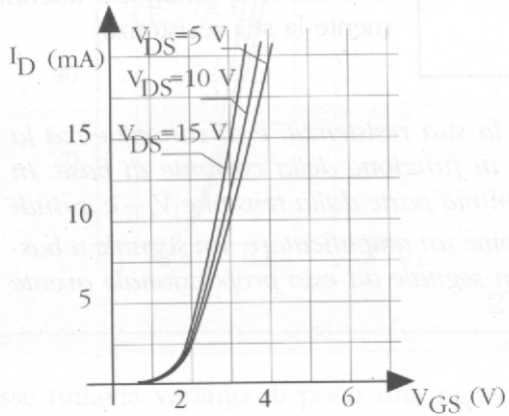

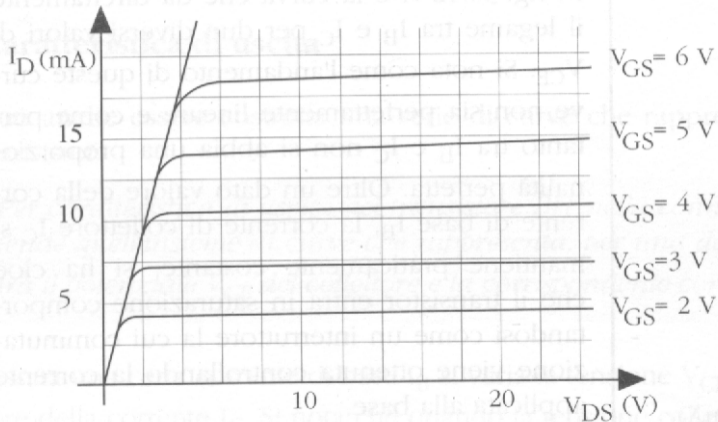



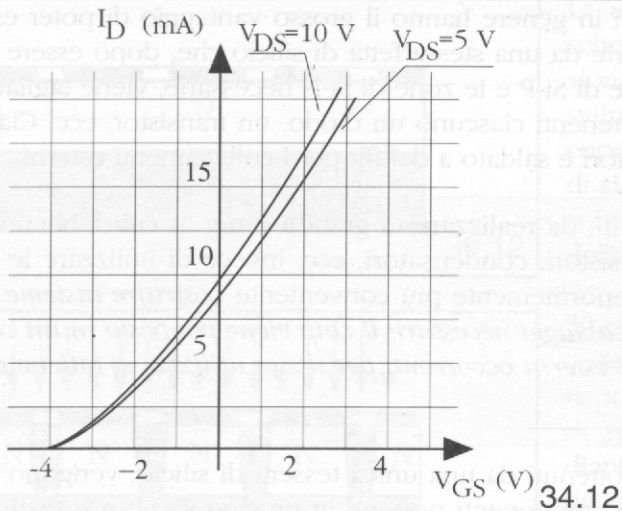

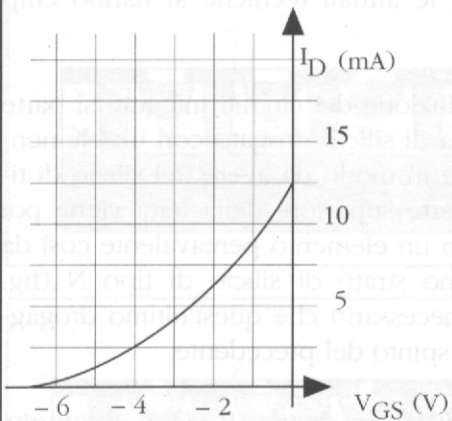

35.12

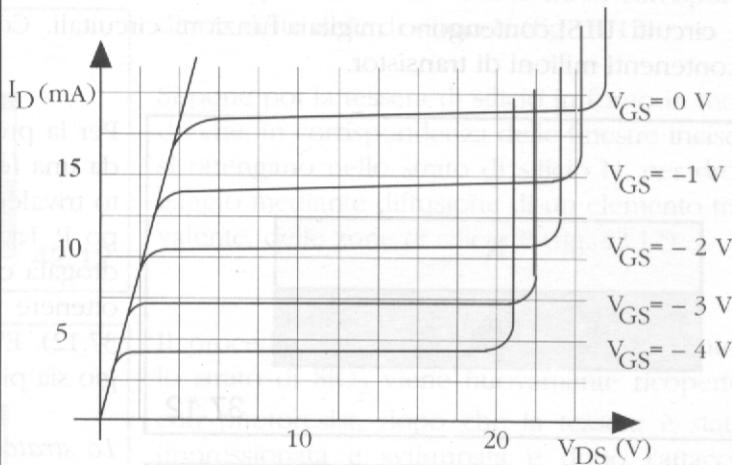

36.12

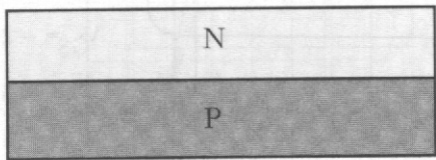

37.12

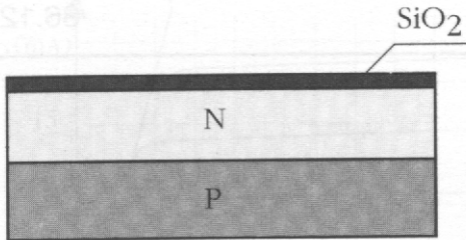

38.12

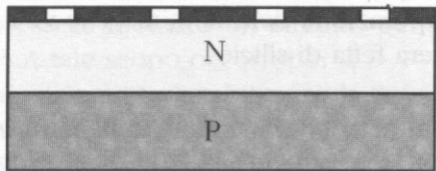

39.12

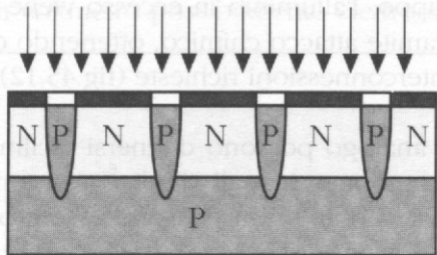

40.12

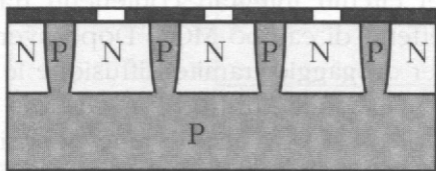

41.12

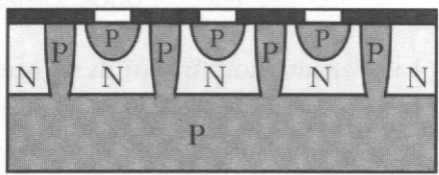

42.12

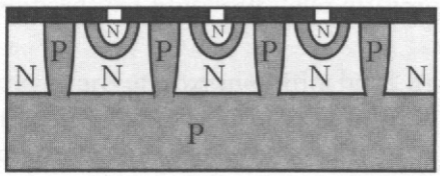

43.12

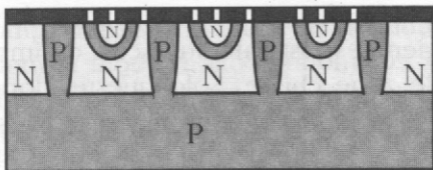

44.12

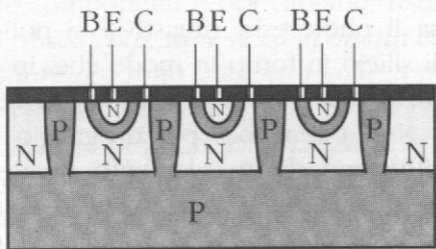

45.12

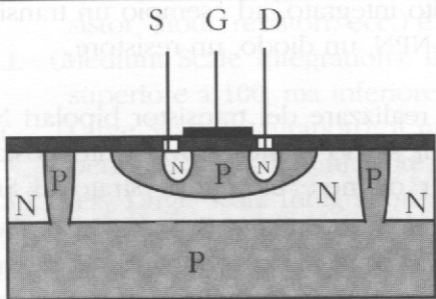

46.12