

NUCLEO

BOBINA

MOLLA

A1

A2

1.19

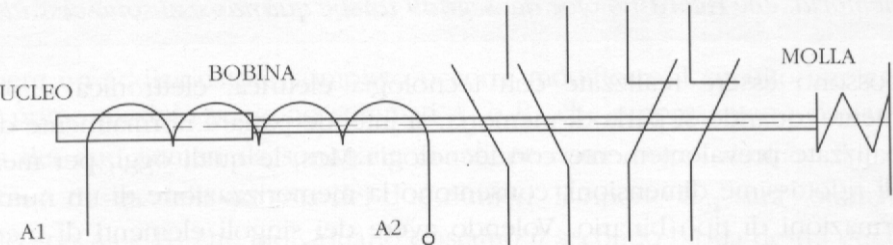

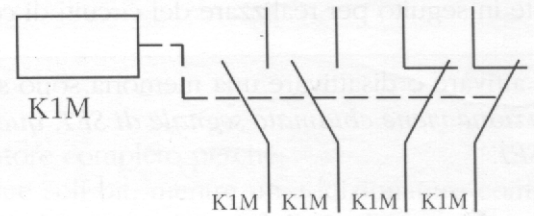
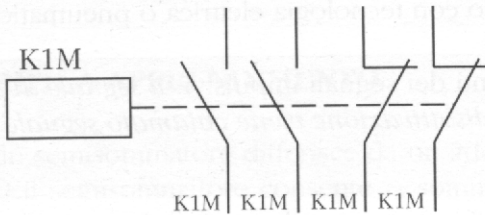

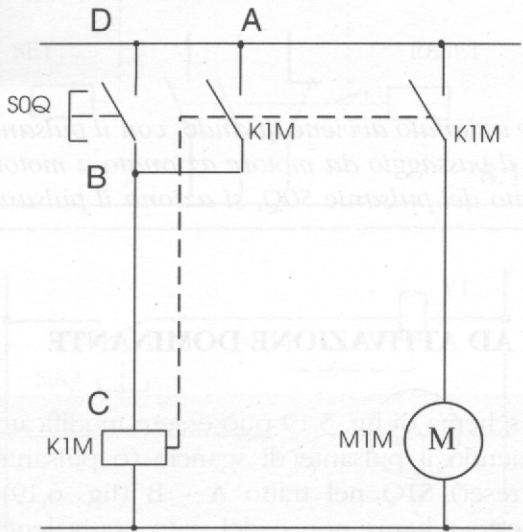

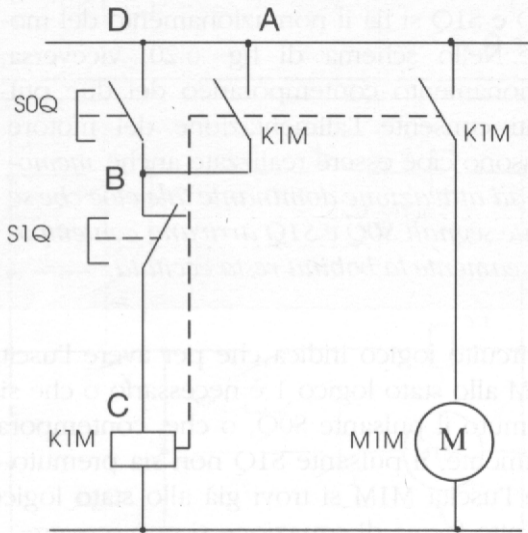

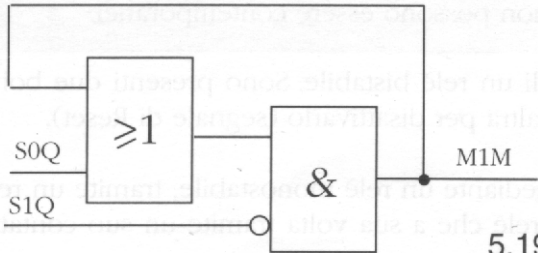

5.19

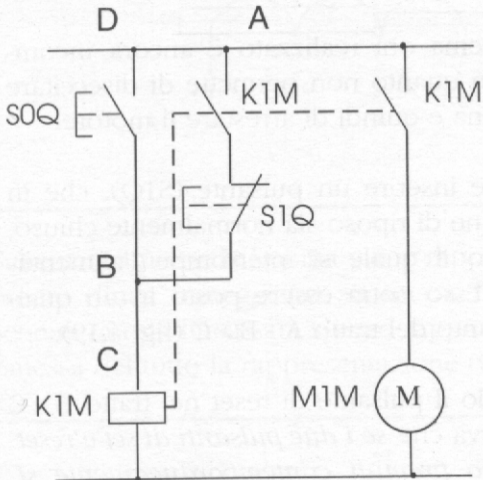

6.19

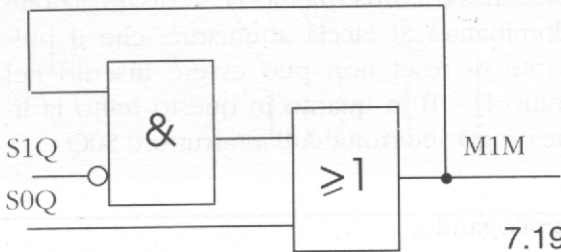

7.19

SET

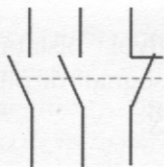

RESET



8.19

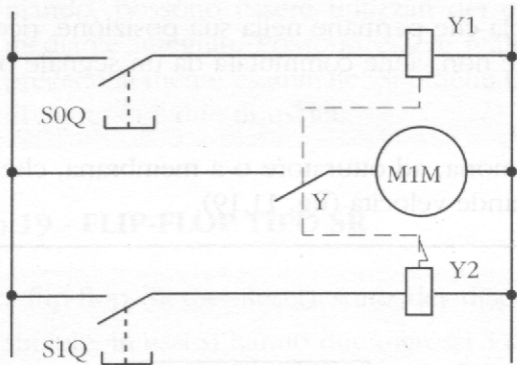

9.19

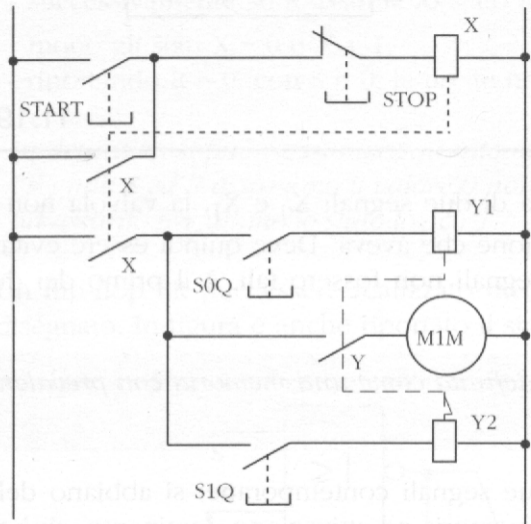

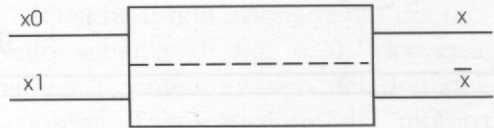
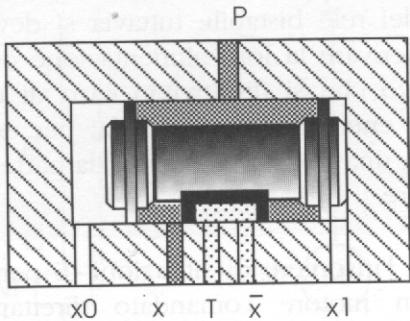

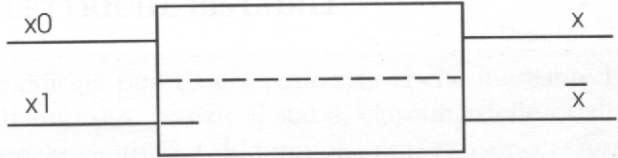

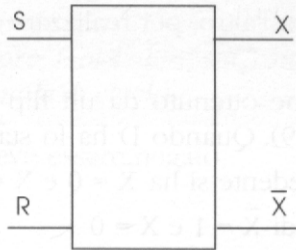
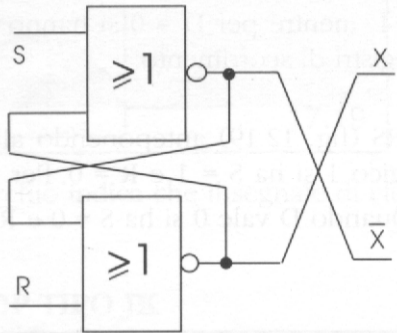

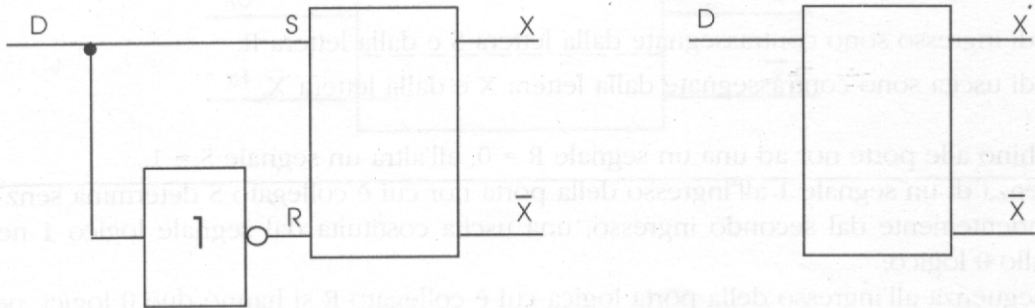

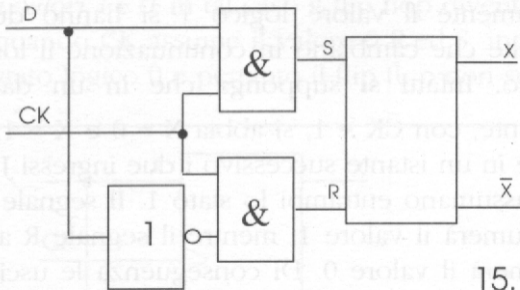

15.19

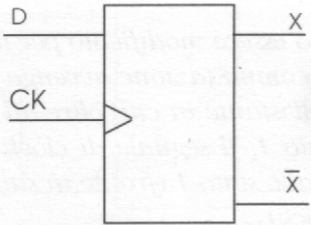

16.19

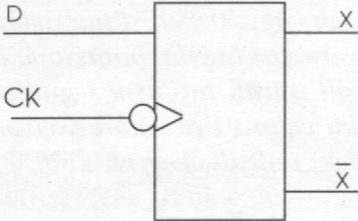

17.19

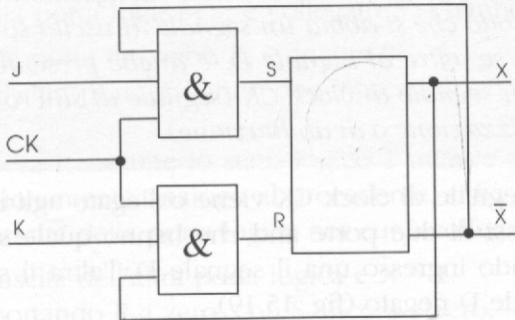

18.19

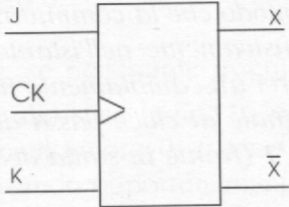

19.19

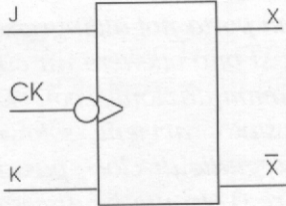

20.19

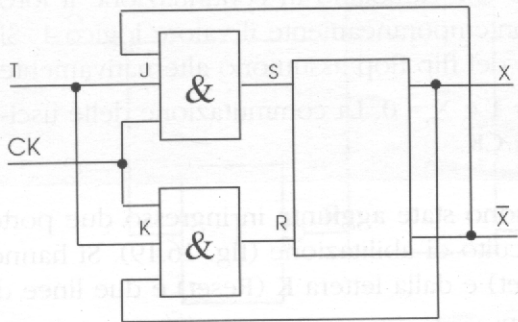

21.19

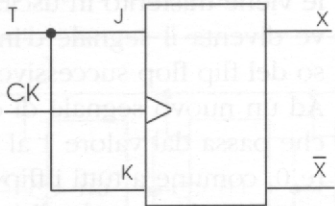

22.19

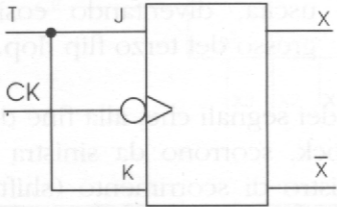

23.19

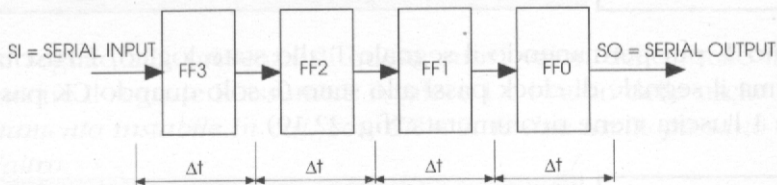
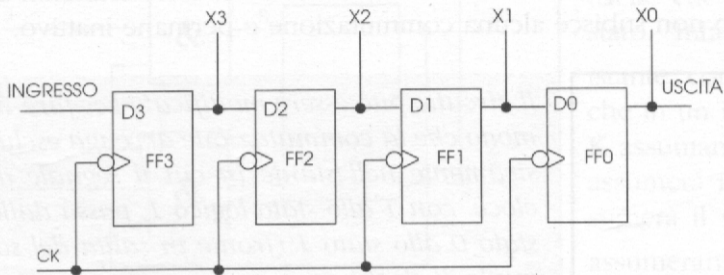

ISTANTE	SI	X3	X2	X1	X0
0+	0	0	0	0	0
1+	1	1	0	0	0
2+	1	1	1	0	0
3+	0	0	1	1	0
4+	1	1	0	1	1

25.19

ISTANTE	SI	X3	X2	X1	X0	SO
0+	0	1	0	1	1	
1+	0	0	1	0	1	1
2+	0	0	0	1	0	1
3+	0	0	0	0	1	0
4+	0	0	0	0	0	1

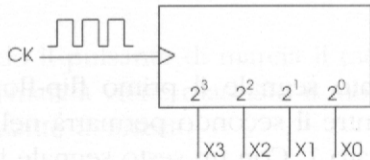
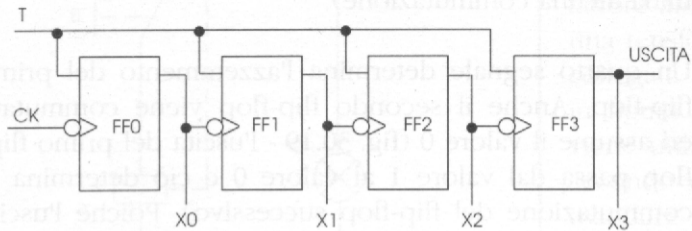

28.19

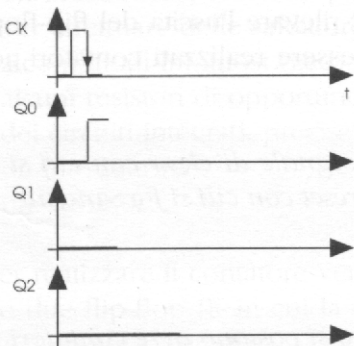

29.19

